

MARINE

Grade 43 ISO Chain	137, 140
Grade 30 ISO Chain	138, 141
BBB Chain	139
Anchor Lead Chain	142
Marine Chain Accessories	143-145
Mooring Chain	146
Cargo Lashing Chain	146
Tuna Chain	147
Trawlex Chain	148
Trawl Door Chain	149
Scallop Chain & Accessories	149
Tickler Chain	149



ACCO G43 Domestic High Test ISO Chain



A high tensile strength carbon steel anchor (windlass) chain with an ISO short link. The short link makes it more flexible and ideally suited as a windlass chain. Check fit or contact windlass manufacturer before purchase. This extra thick hot dip galvanized finish is recommended for all marine applications. **NOT FOR OVERHEAD LIFTING.**



Embossed: G4

Full Drum

Stock #		Trade Size (In.)	Wire Dia. (In.)	Inside Dimensions (In.)		Qty. Per Drum	Net Wt. (Lbs.)	WLL	
Self-Colored	HDG			Length (Nom.)	Width (Min.)			Lbs.	Kgs.
500110402	500140402	1/4	0.274	0.845	0.410	800	586	2,600	1,180
500110502	500140502	5/16	0.329	1.030	0.500	550	570	3,900	1,770
500110632	500140632	3/8	0.394	1.220	0.600	400	595	5,400	2,450
500110702	500140702	7/16	0.467	1.400	0.660	300	645	7,200	3,266
500110802	500140802	1/2	0.510	1.590	0.770	200	507	9,200	4,174
500110902	500140902	5/8	0.625	1.790	0.910	150	582	13,000	5,897



Half Drum



Stock #		Trade Size (In.)	Wire Dia. (In.)	Inside Dimensions (In.)		Qty. Per Drum	Net Wt. (Lbs.)	WLL	
Self-Colored	HDG			Length (Nom.)	Width (Min.)			Lbs.	Kgs.
500110401	500140401	1/4	0.274	0.845	0.410	400	293	2,600	1,180
500110501	500140501	5/16	0.329	1.030	0.500	275	285	3,900	1,770
500110631	500140631	3/8	0.394	1.220	0.600	200	297	5,400	2,450
500110701	500140701	7/16	0.467	1.400	0.660	150	322	7,200	3,266
500110801	500140801	1/2	0.510	1.590	0.770	100	253	9,200	4,174

5 Gallon Square Pail

Stock #		Trade Size (In.)	Wire Dia. (In.)	Inside Dimensions (In.)		Qty. Per Pail	Net Wt. (Lbs.)	WLL	
Self-Colored	HDG			Length (Nom.)	Width (Min.)			Lbs.	Kgs.
501310401	501340401	1/4	0.274	0.845	0.410	134	98	2,600	1,180
501310501	501340501	5/16	0.329	1.030	0.500	90	93	3,900	1,770
501310601	501340601	3/8	0.394	1.220	0.600	64	95	5,400	2,450



Wood Crate



Stock #	Trade Size (In.)	Wire Dia. (In.)	Inside Dimensions (In.)		Qty. Per Crate	Net Wt. (Lbs.)	WLL	
HDG			Length (Nom.)	Width (Min.)			Lbs.	Kgs.
500191733	1/4	0.274	0.845	0.410	3,600	2,628	2,600	1,180
500191734	5/16	0.329	1.030	0.500	2,800	2,903	3,900	1,770
500191735	3/8	0.394	1.220	0.600	1,800	2,672	5,400	2,450
500191736	1/2	0.510	1.590	0.770	1,000	2,533	9,200	4,174
8610327	5/8	0.625	1.790	0.910	600	2,328	13,000	5,897



WARNING Do not exceed Working Load Limits (WLL)! See the SAFETY GUIDELINES section before using these products. Pages 150 - 155.

ACCO G30 Domestic Proof Coil ISO Chain



NOT FOR OVERHEAD LIFTING.

Full Drum

Stock #		Trade Size (In.)	Wire Dia. (In.)	Inside Dimensions (Inches)		Qty. Per Drum	Net Wt. (Lbs.)	Working Load Limit	
Self-Colored	HDG			Length (Nominal)	Width (Minimum)			Lbs.	Kgs.
400100432	400140432	1/4	0.279	1.000	0.507	800	599	1,300	590
400100502	400140502	5/16	0.342	1.100	0.507	550	614	1,900	862
400100602	400140602	3/8	0.404	1.230	0.620	400	644	2,650	1,202
400100802	400140802	1/2	0.512	1.500	0.820	200	525	4,500	2,042
400101032	400141032	5/8	0.628	1.900	1.020	150	557	6,900	3,131
400101232	400141232	3/4	0.779	2.200	1.100	100	595	10,600	4,810

Half Drum

Stock #		Trade Size (In.)	Wire Dia. (In.)	Inside Dimensions (Inches)		Qty. Per Drum	Net Wt. (Lbs.)	Working Load Limit	
Self-Colored	HDG			Length (Nominal)	Width (Minimum)			Lbs.	Kgs.
400100431	400140431	1/4	0.279	1.000	0.507	400	299	1,300	590
400100501	400140501	5/16	0.342	1.100	0.507	275	308	1,900	862
400100601	400140601	3/8	0.404	1.230	0.620	200	322	2,650	1,202
400100801	400140801	1/2	0.512	1.500	0.820	100	262	4,500	2,042

5 Gallon Square Pail

Stock #		Trade Size (In.)	Wire Dia. (In.)	Inside Dimensions (Inches)		Qty. Per Pail	Net Wt. (Lbs.)	Working Load Limit	
Self-Colored	HDG			Length (Nominal)	Width (Minimum)			Lbs.	Kgs.
401100431	401140431	1/4	0.279	1.000	0.507	141	106	1,300	590
401100501	401140501	5/16	0.342	1.100	0.507	92	103	1,900	862
401100601	401140601	3/8	0.404	1.230	0.620	63	101	2,650	1,202
401100801	401140801	1/2	0.512	1.500	0.820	36	94	4,500	2,042



Embossed: G3



Do not exceed Working Load Limits (WLL)! See the SAFETY GUIDELINES section before using these products. Pages 150 - 155.



ACCO BBB Chain

A low carbon steel, general purpose chain, with a short compact link. The short link is ideally suited for anchor chain. Check fit for windlass manufacturer's specifications before purchase.
NOT FOR OVERHEAD LIFTING.

Full Drum

Stock #	Trade Size (Inches)	Wire Dia. (Inches)	Inside Dimensions (Inches)		Qty. Per Drum	Net Wt. (Lbs.)	Working Load Limit	
			Length (Nominal)	Width (Minimum)			Lbs.	Kgs.
410140402	1/4	0.274	0.870	0.430	800	590	1,300	590
410140502	5/16	0.328	1.000	0.500	550	646	1,900	862
410140602	3/8	0.392	1.090	0.620	400	640	2,650	1,202
410140802	1/2	0.509	1.340	0.750	200	546	4,500	2,042

5 Gallon Square Pail

Stock #	Trade Size (Inches)	Wire Dia. (Inches)	Inside Dimensions (Inches)		Qty. Per Pail	Net Wt. (Lbs.)	Working Load Limit	
			Length (Nominal)	Width (Minimum)			Lbs.	Kgs.
411140402	1/4	0.274	0.870	0.430	141	104	1,300	590
411140502	5/16	0.328	1.000	0.500	92	108	1,900	862
411140602	3/8	0.392	1.090	0.620	63	100	2,650	1,202

Wood Crate

Stock #	Trade Size (Inches)	Wire Dia. (Inches)	Inside Dimensions (Inches)		Qty. Per Crate	Net Wt. (Lbs.)	Working Load Limit	
			Length (Nominal)	Width (Minimum)			Lbs.	Kgs.
400191733	1/4	0.274	0.870	0.430	3600	2,657	1,300	590
400191734	5/16	0.328	1.000	0.500	2800	3,286	1,900	862
400191735	3/8	0.392	1.090	0.620	1800	2,878	2,650	1,202
400191736	1/2	0.509	1.340	0.750	1000	2,732	4,500	2,042



Embossed: 3B



Do not exceed Working Load Limits (WLL)!
 See the SAFETY GUIDELINES section before using these products. Pages 150 - 155.

Embossed: HG4



Boatman's Pride G43 High Test ISO Chain

NOT FOR OVERHEAD LIFTING.

Full Drum

Stock #	Trade Size (Inches)	Wire Dia. (Inches)	Inside Dimensions (Inches)		Qty. Per Drum	Net Wt. (Lbs.)	Working Load Limit	
			Length (Nominal)	Width (Minimum)			Lbs.	Kgs.
700140402	1/4	0.274	0.845	0.400	800	598	2,600	1,180
700140502	5/16	0.330	1.030	0.490	550	584	3,900	1,770
700140632	3/8	0.399	1.220	0.580	400	594	5,400	2,450

Half Drum

Stock #	Trade Size (Inches)	Wire Dia. (Inches)	Inside Dimensions (Inches)		Qty. Per Drum	Net Wt. (Lbs.)	Working Load Limit	
			Length (Nominal)	Width (Minimum)			Lbs.	Kgs.
700140401	1/4	0.274	0.845	0.400	400	299	2,600	1,180
700140501	5/16	0.330	1.030	0.490	275	292	3,900	1,770
700140631	3/8	0.399	1.220	0.580	200	297	5,400	2,450

Pail

Stock #	Trade Size (Inches)	Wire Dia. (Inches)	Inside Dimensions (Inches)		Qty. Per Pail	Net Wt. (Lbs.)	Working Load Limit	
			Length (Nominal)	Width (Minimum)			Lbs.	Kgs.
700191732	1/4	0.274	0.845	0.400	100	75	2,600	1,180
701340801	5/16	0.330	1.030	0.490	125	133	3,900	1,770

Wood Crate

Stock #	Trade Size (Inches)	Wire Dia. (Inches)	Inside Dimensions (Inches)		Qty. Per Drum	Net Wt. (Lbs.)	Working Load Limit	
			Length (Nominal)	Width (Minimum)			Lbs.	Kgs.
700191733	1/4	0.274	0.845	0.400	3,600	2,693	2,600	1,180
700191734	5/16	0.330	1.030	0.490	2,800	2,971	3,900	1,770
8610833	3/8	0.399	1.220	0.580	1,800	2,673	5,400	2,450



Do not exceed Working Load Limits (WLL)! See the SAFETY GUIDELINES section before using these products. Pages 150 - 155.



Embossed: HG3

Boatman's Pride G30 Proof Coil ISO Chain

NOT FOR OVERHEAD LIFTING.

Full Drum

Stock #	Trade Size (Inches)	Wire Dia. (Inches)	Inside Dimensions (Inches)		Qty. Per Drum	Net Wt. (Lbs.)	Working Load Limit	
			Length (Nominal)	Width (Minimum)			Lbs.	Kgs.
600140432	1/4	0.279	1.000	0.507	800	584	1,300	590
600140502	5/16	0.342	1.100	0.507	550	600	1,900	862
600140602	3/8	0.399	1.230	0.620	400	628	2,650	1,202

Half Drum

Stock #	Trade Size (Inches)	Wire Dia. (Inches)	Inside Dimensions (Inches)		Qty. Per Drum	Net Wt. (Lbs.)	Working Load Limit	
			Length (Nominal)	Width (Minimum)			Lbs.	Kgs.
600140431	1/4	0.279	1.000	0.507	400	292	1,300	590
600140501	5/16	0.342	1.100	0.507	275	300	1,900	862
600140601	3/8	0.399	1.230	0.620	200	314	2,650	1,202

Pail

Stock #	Trade Size (Inches)	Wire Dia. (Inches)	Inside Dimensions (Inches)		Qty. Per Pail	Net Wt. (Lbs.)	Working Load Limit	
			Length (Nominal)	Width (Minimum)			Lbs.	Kgs.
601140431	1/4	0.279	1.000	0.507	141	103	1,300	590
601140501	5/16	0.342	1.100	0.507	92	100	1,900	862
601140601	3/8	0.399	1.230	0.620	63	99	2,650	1,202



Do not exceed Working Load Limits (WLL)! See the SAFETY GUIDELINES section before using these products. Pages 150 - 155.

Boatman's Pride Anchor Lead Chains

Double Coated for Double Duty

- Protects Decks and Hulls
- Hot Dipped Galvanized Undercoat
- Heat Cured White Polymer Overcoat or Heavy Duty Vinyl Coating

Available in three chain sizes and 2 coatings. Pre-cut leads have a large end link welded on one end for easy hook up to the anchor line. Heavy duty protection assures years of dependable service.

NOT FOR OVERHEAD LIFTING.

Polymer
or Vinyl Coated
(Vinyl coated shown)



Heavy
Duty Hot
Galvanized
Plating



5 Gallon Square Pail

Stock #		Trade Size (Inches)	Wire Dia. (Inches)	Inside Dimensions (Inches)		Qty. Per Pail	Net Wt. (Lbs.)	Working Load Limit	
White Polymer Coated HDG Chain	HDG			Length (Nominal)	Width (Minimum)			Lbs.	Kgs.
402080302	---	3/16	0.217	0.950	0.405	154	70	800	363
402080402	---	1/4	0.274	1.236	0.480	96	65	1,300	590
402080502	---	5/16	0.328	1.285	0.480	60	68	1,900	862

Pre-cut Anchor Lead Chains - Shelf Pack (4 boxes per pkg.)

Stock #		Trade Size	Wire Dia. (Inches)	Inside Dimensions (Inches)		Qty. Per Package	Lbs. Per Package	Working Load Limit	
White Polymer Coated HDG Chain	HDG			Length (Nominal)	Width (Minimum)			Lbs.	Kgs.
406980304	---	3/16" x 4'	0.217	0.950	0.405	4	7	800	363
406980405	---	1/4" x 5'	0.274	1.236	0.480	4	15	1,300	590
406980506	---	5/16" x 6'	0.328	1.285	0.480	4	26	1,900	862

Pre-cut Anchor Lead Chains - Shelf Pack (5 bags per pkg.)

Stock #		Trade Size	Wire Dia. (Inches)	Inside Dimensions (Inches)		Qty. Per Pkg.	Coated HDG Lbs. Per Pkg.	HDG Lbs. Per Pkg.	Working Load Limit	
White Vinyl Coated HDG Chain	HDG			Length (Nominal)	Width (Minimum)				Lbs.	Kgs.
406980324	406940304	3/16" x 4'	0.217	0.950	0.405	5	12	9	800	363
406980425	406940405	1/4" x 5'	0.274	1.236	0.480	5	22	16	1,300	590
406980526	406940506	5/16" x 6'	0.328	1.285	0.480	5	36	24	1,900	862



Do not exceed Working Load Limits (WLL)! See the SAFETY GUIDELINES section before using these products. Pages 150 - 155.

Anchor Rode Swivel

- Easy Swiveling Design
- Stainless Steel Pin Locks
- Grade 40 High Test Steel
- Hot Dip Galvanized

NOT FOR OVERHEAD LIFTING.

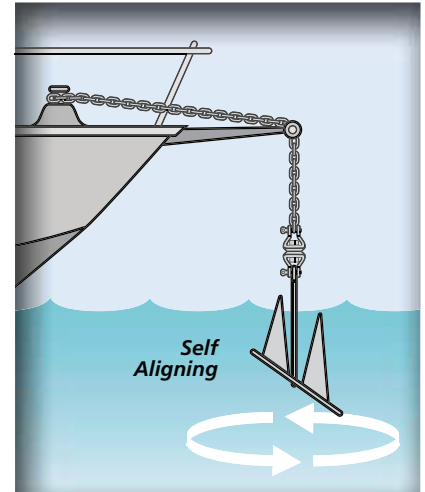

Stock #	Trade Size (Inches)	Qty. Per Package	Lbs. Per Each	Working Load Limit	
				Lbs.	Kgs.
440640011	1/4-5/16	25	30	1,500	681

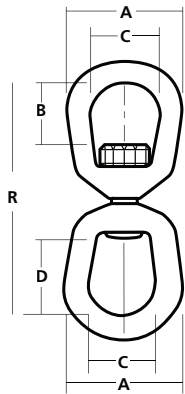

Forged Anchor Eye-Eye Swivels

Stock #	Trade Size (Inches)	Dimensions (Inches)					Qty. Per Pkg.	Lbs. Per Each	Working Load Limit	
		A	B	C	D	R			Lbs.	Kgs.
8170241	1/4	1.250	0.688	0.750	1.063	2.938	25	0.22	850	386
8170341	5/16	1.625	0.813	1.000	1.250	3.563	25	0.33	1,250	567
8170441	3/8	2.000	0.938	1.250	1.500	4.313	10	0.66	2,250	1,021
8170541	1/2	2.500	1.313	1.500	2.000	5.438	10	1.43	3,600	1,634
8170641	5/8	3.000	1.563	1.750	2.375	6.563	5	2.49	5,200	2,360
8170741	3/4	3.500	1.750	2.000	2.625	7.188	5	4.08	7,200	3,268



NOT FOR OVERHEAD LIFTING.

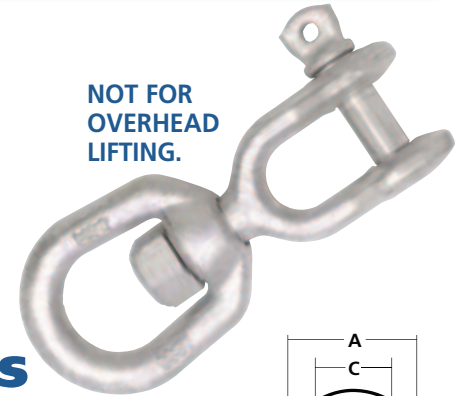

NOT FOR OVERHEAD LIFTING.

Forged Anchor Jaw-Eye Swivels

Stock #	Trade Size (Inches)	Dimensions (Inches)							Qty. Per Pkg.	Lbs. Per Each	Working Load Limit	
		A	B	C	K	D	Pin Dia.	R			Lbs.	Kgs.
8171241	1/4	1.250	0.688	0.750	0.469	0.875	0.250	2.625	25	0.21	850	386
8171341	5/16	1.625	0.813	1.000	0.500	0.875	0.313	2.938	25	0.32	1,250	567
8171441	3/8	2.000	0.938	1.250	0.625	1.063	0.375	3.625	10	0.61	2,250	1,021
8171541	1/2	2.500	1.313	1.500	0.750	1.313	0.500	4.500	10	1.24	3,600	1,634
8171641	5/8	3.000	1.563	1.750	0.938	1.500	0.625	5.313	5	2.56	5,200	2,360
8171741	3/4	3.500	1.750	2.000	1.125	1.750	0.750	6.063	5	4.17	7,200	3,268

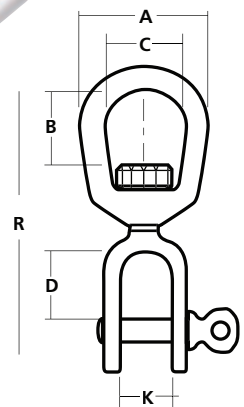

Do not exceed Working Load Limits (WLL)! See the SAFETY GUIDELINES section before using these products. Pages 150 - 155.

**NOT FOR
OVERHEAD
LIFTING.**

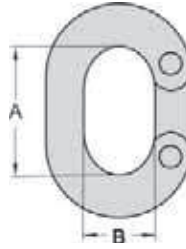

Oval Connecting Links

Stock #	Trade Size (Inches)	Dimensions (Inches)		Qty. Per Pkg.	Lbs. Per Each	Working Load Limit	
		A	B			Lbs.	Kgs.
440840403	1/4	0.880	0.440	10	0.06	1,300	590
440840503	5/16	0.940	0.500	10	0.11	1,900	862
440840603	3/8	1.200	0.560	10	0.18	2,650	1,202
440840802	1/2	1.440	0.660	10	0.36	4,500	2,042
6800035	5/8	1.890	0.780	---	0.75	10,000	4,535

**NOT FOR
OVERHEAD
LIFTING.**

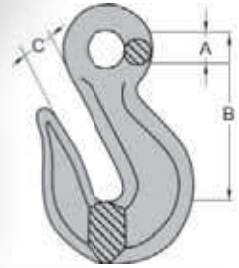

G30 Eye Grab Hooks

Stock #	Trade Size (Inches)	Dimensions (Inches)			Qty. Per Pkg.	Lbs. Per Each	Working Load Limit	
		A	B	C			Lbs.	Kgs.
440242442	5/16	0.600	2.180	0.360	10	0.52	1,900	862
440242443	3/8	0.710	2.630	0.430	10	0.78	2,650	1,202
440242445	1/2	0.920	3.400	0.560	5	1.60	4,500	2,042



**NOT FOR
OVERHEAD
LIFTING.**

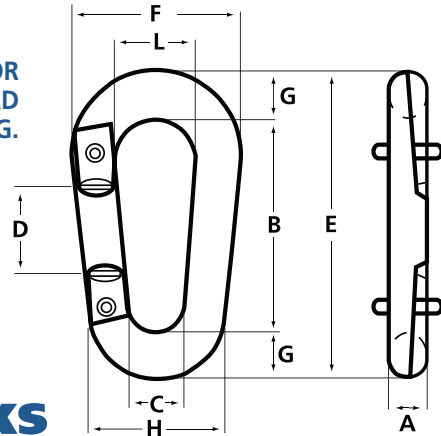

Pear Shaped Connecting Links

Stock #	Trade Size (Inches)	Dimensions (Inches)									Lbs. Per Each	Working Load Limit	
		A	B	C	E	D	F	G	H	L		Lbs.	Kgs.
6800023	3/8	0.440	2.010	0.560	0.830	2.950	1.660	0.470	1.440	0.780	0.31	2,250	1,021
6800021	1/2	0.500	2.490	0.690	1.000	3.630	2.000	0.570	1.720	1.000	0.56	4,000	1,815



Do not exceed Working Load Limits (WLL)!
See the SAFETY GUIDELINES section before using these products. Pages 150 - 155.

Peer-Lift Screw Pin Anchor Shackles

RR-C-271F, Type IVA, Class 2, Grade A - Ideal for those applications where frequent pin removal is needed.

- Meet or exceed FED SPEC RR-C-271 requirements
- Also available in smaller package quantities
- Hot Dipped Galvanized to ASTM A153

Stock #	Trade Size (Inches)	Pin Dia. (D)	Dimensions (Inches)					Qty. Per Pkg.	Lbs. Per Each	Working Load Limit (Ton)
			W	A	E (Min)	G (Max)	B (Min)			
8058105	3/16	1/4	0.375	0.875	0.562	0.625	0.180	250	0.06	1/3
8058205	1/4	5/16	0.469	1.125	0.750	0.875	0.240	250	0.11	1/2
8058305	5/16	3/8	0.531	1.250	0.812	1.000	0.300	150	0.19	3/4
8058405	3/8	7/16	0.656	1.438	0.938	1.125	0.360	100	0.31	1
8059205	7/16	1/2	0.750	1.688	1.062	1.250	0.420	100	0.49	1-1/2
8058505	1/2	5/8	0.812	1.875	1.188	1.375	0.480	50	0.73	2
8058605	5/8	3/4	1.062	2.375	1.500	1.875	0.590	25	1.37	3-1/4
8058705	3/4	7/8	1.250	2.812	1.750	2.125	0.710	25	2.36	4-3/4
8058805	7/8	1	1.438	3.312	2.000	2.375	0.830	10	3.62	6-1/2
8058905	1	1-1/8	1.688	3.750	2.312	2.625	0.950	10	5.07	8-1/2
8058005	1-1/8	1-1/4	1.812	4.250	2.625	2.875	1.070	5	7.41	9-1/2
8059005	1-1/4	1-3/8	2.031	4.688	2.875	3.250	1.190	5	9.51	12
8059305	1-3/8	1-1/2	2.250	5.250	3.250	3.500	1.310	5	13.25	13-1/2
8059105	1-1/2	1-5/8	2.375	5.750	3.375	3.750	1.420	5	17.70	17
8059405	1-3/4	2	2.875	7.000	4.500	4.500	1.660	1	30.40	25
8059505	2	2-1/4	3.250	7.750	5.250	5.250	1.900	1	45.04	35

NOT FOR OVERHEAD LIFTING.

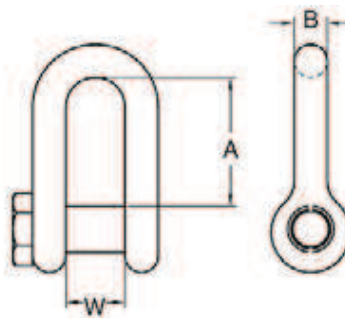
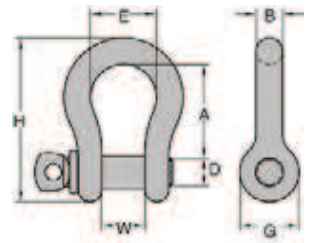

Forged Trawling Shackles

NOT FOR OVERHEAD LIFTING.

Stock #	Trade Size (Inches)	Pin Dia. (D)	Dimensions (Inches)			Qty. Per Pkg.	Lbs. Per Each	Working Load Limit (Ton)
			W	A	B			
H9626-0824	1/2	5/8	0.830	1.690	0.473	10	0.60	5/8
H9626-0924	5/8	3/4	1.100	1.970	0.590	10	1.25	1
H9626-1024	3/4	7/8	1.340	2.360	0.740	10	2.20	1-3/8
H9626-1124	7/8	1	1.420	2.880	0.820	5	3.00	1-7/8
H9626-1224	1	1-1/8	1.690	3.030	0.940	5	4.50	2-1/2



Do not exceed Working Load Limits (WLL)! See the SAFETY GUIDELINES section before using these products. Pages 150 - 155.

MARINE

Use a Shackle for Maximum Flexibility

Use a shackle to add on to an existing span of chain or connect it in the middle of a span for maximum versatility.

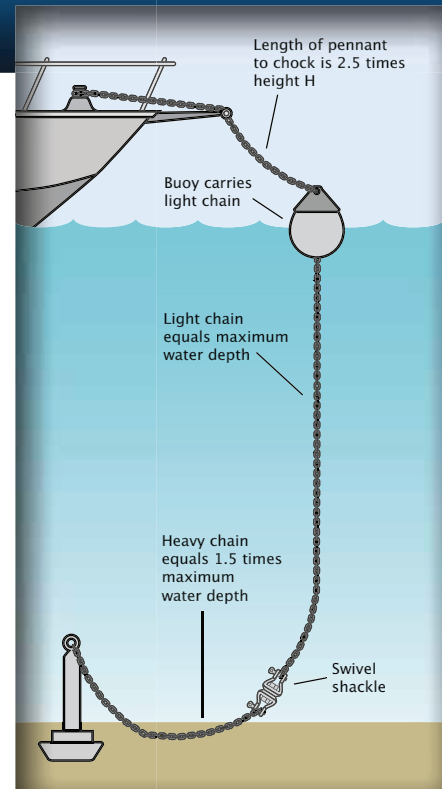
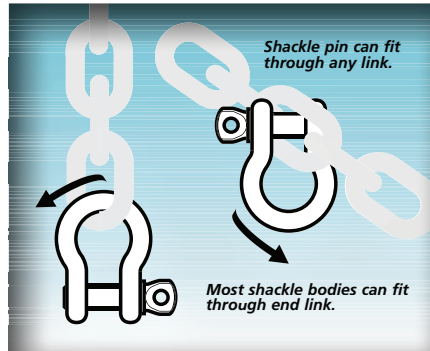

Embossed: MC every 8-10 links
USA: every link

ACCO Mooring Chain

The Best Chain for a Tough Job

Compare ACCO's mooring chain to proof coil chain and it's easy to see that ACCO mooring chain is stronger.

Plus the hot dip galvanized coating has 30% more zinc per unit volume than mechanical coating.

The long link design permits the hook-up of shackles anywhere on the chain, not just on end links as with most chains.

NOT FOR OVERHEAD LIFTING.

High Quality Steel
Hot Dip Galvanized
Long Link Design

Full Drum

Stock #	Trade Size (Inches)	Wire Dia. (Inches)	Inside Link Dimensions (Inches)		Qty. Per Drum	Net Wt. (Lbs.)	Working Load Limit	
			Length (Nominal)	Width (Minimum)			Lbs.	Kgs.
500140650	3/8	0.394	1.630	0.650	200	287	4,050	1,837
500140850	1/2	0.519	2.000	0.870	200	503	6,900	3,130
500141052	5/8	0.630	2.530	0.920	150	500	9,750	4,422
500141050	5/8	0.630	2.530	0.920	200	665	9,750	4,422
500141150	3/4	0.781	2.990	1.040	100	532	15,000	6,804



ACCO Cargo Lashing Chain - Full Drum

Stock #	Trade Size (Inches)	Wire Dia. (Inches)	Inside Link Dimensions (Inches)		Qty. Per Drum	Net Wt. (Lbs.)	Working Load Limit	
			Length (Nominal)	Width (Minimum)			Lbs.	Kgs.
560141301	1/2	0.531	3.150	0.930	460	997	11,300	5,125



Do not exceed Working Load Limits (WLL)!
See the SAFETY GUIDELINES section before using these products. Pages 150 - 155.

ACCO Tuna Chain

The Best Chain for a Tough Job.

ACCO uses high quality steel, especially formulated and heat treated for tuna fishing. Every heat treated lot is sampled and destructively tested for material strength and link elongation. All Tuna Net Chain is then proof tested, 100%, every link.

ACCO Tuna Net Chain is then continuously Hot Dip Galvanized to provide the deep strong protective coating you have come to expect which with over 30% more zinc per unit volume than mechanical coating. In the hot dip process the galvanized zinc coating is alloyed with the base steel creating a METALLURGICAL bond that is several orders of magnitude stronger than mechanical bonding. This zinc-steel bond is immune to further corrosion for the life of the zinc. If the chain's steel base is exposed by cuts or nicks, the base steel will not rust until the nearby zinc is consumed.



**NOT FOR
OVERHEAD
LIFTING.**

Full Steel Drum

Stock #	Trade Size (Inches)	Wire Dia. (Inches)	Inside Link Dimensions (Inches)		Qty. Per Drum	Net Wt. (Lbs.)	Working Load Limit	
			Length (Nominal)	Width (Minimum)			Lbs.	Kgs.
520140692	3/8	0.394	1.330	0.570	400	580	6,600	2,994
520140792	7/16	0.467	1.370	0.750	300	670	8,750	3,969
520140892	1/2	0.519	1.720	0.750	200	485	11,300	5,125
520140992	9/16	0.551	1.700	0.850	200	601	12,150	5,510
520141092	5/8	0.630	1.930	0.865	150	566	15,800	7,167
520141292	3/4	0.750	2.420	1.140	100	575	24,700	11,202



Do not exceed Working Load Limits (WLL)! See the SAFETY GUIDELINES section before using these products. Pages 150 - 155.

ACCO Trawlex Chain

- Surface finish - Peer blue
- Packing - steel drums (*Pallet boxes available on request*)
- High strength special steels, hardened and tempered, resistance to shock loading and wear

**NOT FOR
OVERHEAD
LIFTING.**



Full Drum - Black

Stock #	Trade Size (Inches)	Wire Dia. (Inches)	Inside Dimensions (Inches)		Qty. Per Drum	Net Wt. (Lbs.)	Working Load Limit	
			Length (Nom.)	Width (Min.)			Lbs.	Kgs.
550110601	3/8	0.404	1.630	0.650	200	286	6,600	2,994
550110802	1/2	0.528	2.000	0.870	200	494	11,300	5,125
550111002	5/8	0.630	2.530	0.920	200	666	15,800	7,166

Wood Crate - Black

Stock #	Trade Size (Inches)	Wire Dia. (Inches)	Inside Dimensions (Inches)		Qty. Per Crate	Net Wt. (Lbs.)	Working Load Limit	
			Length (Nom.)	Width (Min.)			Lbs.	Kgs.
550110603	3/8	0.404	1.630	0.650	2000	2,860	6,600	2,994
550110803	1/2	0.528	2.000	0.870	1000	2,470	11,300	5,125
550111003	5/8	0.630	2.530	0.920	1000	3,330	15,800	7,166

Full Drum - Blue Medium Link

Stock #	Trade Size		Wire Dia. (In.)	Inside Dimensions (Inches)		Meters Per Drum	Net Wt. (Kgs.)	Working Load Limit	
	Inches	MM		Length (Nom.)	Width (Min.)			Lbs.	Kgs.
5571023	3/8	10	0.404	1.630	0.650	200	426	8,800	3,992
5571323	1/2	13	0.529	2.000	0.870	150	551	14,602	6,623
5571623	5/8	16	0.630	2.530	0.920	100	496	22,050	10,002
5571923	3/4	19	0.781	2.990	1.040	75	579	31,415	14,250
5572223	7/8	22	0.906	3.421	1.320	50	542	38,575	17,497

Full Drum - Blue Long Link

Stock #	Trade Size		Wire Dia. (In.)	Inside Dimensions (Inches)		Meters Per Drum	Net Wt. (Kgs.)	Working Load Limit	
	Inches	MM		Length (Nom.)	Width (Min.)			Lbs.	Kgs.
5580923	11/32	9	0.360	2.090	0.600	200	296	5,620	2,549
5581123	3/8	11	0.437	2.520	0.760	150	329	10,195	4,624
5581323	1/2	13	0.531	3.150	0.930	150	471	14,602	6,623
5581623	5/8	16	0.630	3.940	1.030	100	484	22,050	10,002
5581923	3/4	19	0.781	3.940	1.130	75	539	31,415	14,250
5582223	7/8	22	0.875	4.730	1.320	50	441	38,575	17,497



Do not exceed Working Load Limits (WLL)! See the SAFETY GUIDELINES section before using these products. Pages 150 - 155.



ACCO Trawl Door Chain -

Full Drum - (Steel) **NOT FOR OVERHEAD LIFTING.**

Stock #	Trade Size (Inches)	Wire Dia. (Inches)	Inside Dimensions (Inches)		Qty. Per Drum	Net Wt. (Lbs.)	Working Load Limit	
			Length (Nom.)	Width (Min.)			Lbs.	Kgs.
500140612	3/8	0.404	1.000	0.507	400	582	5,400	2,449
500140611	3/8	0.404	1.000	0.507	200	291	5,400	2,449
500140812	1/2	0.512	1.595	0.620	200	498	9,200	4,173

ACCO Scallop Sweep Chain -

Full Drum - (Steel) **NOT FOR OVERHEAD LIFTING.**

Stock #	Trade Size (In.)	Wire Dia. (In.)	Inside Dimensions (Inches)		Qty. Per Drum	Net Wt. (Lbs.)	Working Load Limit	
			Length (Nom.)	Width (Min.)			Lbs.	Kgs.
500151002	5/8	0.630	1.930	0.865	150	619	14,000	6,350



ACCO Welded Scallop Rings

5 Gallon Square Pail



ACCO Scallop Links - 5 Gallon Square Pail

Stock #	Trade Size (Inches)	Wire Dia. (Inches)	Qty. Per Pail	Lbs. Per Pail
Self-Colored	7/16 x 4	0.438	81	50
8370841	7/16 x 4	0.438	81	50

Stock #	Trade Size (Inches)	Wire Dia. (Inches)	Qty. Per Pail	Lbs. Per Pail
Self-Colored	3/8	0.375	350	50
8371241	3/8	0.375	350	50

ACCO Super-Tuf Tickler Chain

Full Drum - (Steel)

Stock #	Trade Size (Inches)	Wire Dia. (Inches)	Inside Dimensions (Inches)		Qty. Per Drum	Net Wt. (Lbs.)
			Length (Nom.)	Width (Min.)		
Self Colored	5/16	0.332	1.111	0.465	275	276
5641384	5/16	0.332	1.111	0.465	275	276
5641484	3/8	0.404	1.656	0.616	400	544
5641684	1/2	0.528	2.035	0.860	200	460
5641884	5/8	0.625	2.530	0.902	200	666



Do not exceed Working Load Limits (WLL)!
See the SAFETY GUIDELINES section before using these products. Pages 150 - 155.